

Varenummer: 03020040
 Beskrivelse: Fluro ledhoved GIRSW 40-RR
 Komplet rustfast

Mål

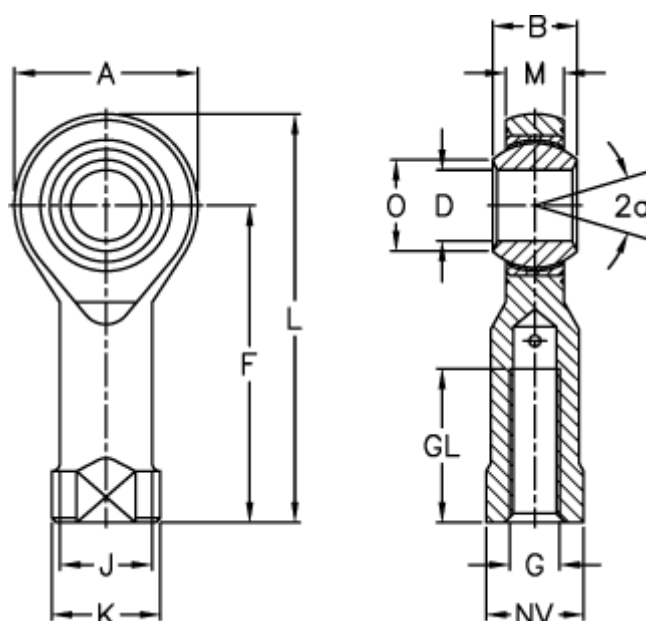

A	= 90	J	= 57
a (grader)	= 16	K	= 69
B	= 49	L	= 187
D	= 40	M	= 35
Dynamisk belastning C (kN)	= 286	NV	= 60
F	= 142	O	= 44.2
G	= M42x2	Statisk belastning C0 (kN)	= 235
GL	= 60	Tilladelige o/min	= 100

Vægt (g) = 2270